

SINGLE-SUPPLY RAIL-TO-RAIL OPERATIONAL AMPLIFIERS

FEATURES

- **Controlled Baseline**
 - One Assembly Site
 - One Test Site
 - One Fabrication Site
- **Extended Temperature Performance of –55°C to 125°C**
- **Enhanced Diminishing Manufacturing Sources (DMS) Support**
- **Enhanced Product-Change Notification**
- **Qualification Pedigree⁽¹⁾**

(1) Component qualification in accordance with JEDEC and industry standards to ensure reliable operation over an extended temperature range. This includes, but is not limited to, Highly Accelerated Stress Test (HAST) or biased 85/85, temperature cycle, autoclave or unbiased HAST, electromigration, bond intermetallic life, and mold compound life. Such qualification testing should not be viewed as justifying use of this component beyond specified performance and environmental limits.

- **Rail-to-Rail Input**
- **Rail-to-Rail Output (Within 1 mV)**
- **Wide Bandwidth: 5.5 MHz**
- **High Slew Rate: 6 V/μs**
- **Low THD+Noise: 0.0007% (f = 1 kHz)**
- **Low Quiescent Current: 750 μA/channel**
- **Single, Dual, and Quad Versions**

APPLICATIONS

- **Driving Analog-to-Digital (A/D) Converters**
- **PCMCIA Cards**
- **Data Acquisition**
- **Process Control**
- **Audio Processing**
- **Communications**
- **Active Filters**
- **Test Equipment**

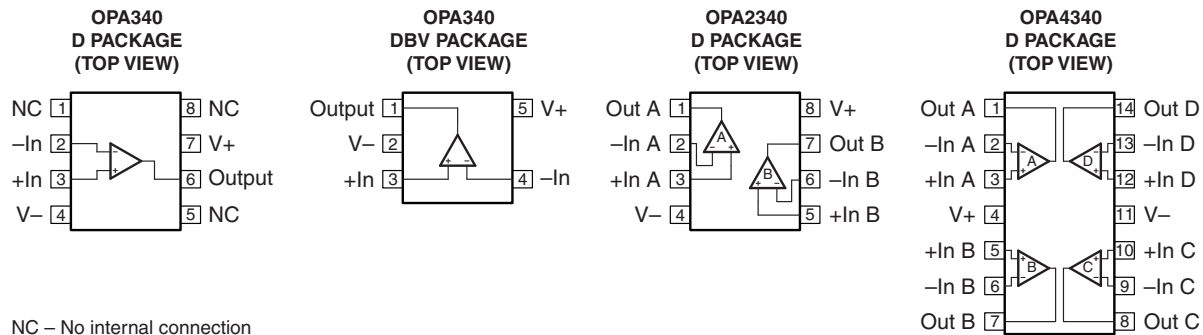

DESCRIPTION

OPA340 series rail-to-rail CMOS operational amplifiers are optimized for low-voltage, single-supply operation. Rail-to-rail input/output and high-speed operation make them ideal for driving sampling analog-to-digital (A/D) converters. They are also well-suited for general purpose and audio applications as well as providing current/voltage conversion at the output of digital-to-analog (D/A) converters. Single, dual, and quad versions have identical specifications for design flexibility.

The OPA340 series operate on a single supply as low as 2.7 V with an input common-mode voltage range that extends 500 mV below ground and 500 mV above the positive supply. Output voltage swing is to within 1 mV of the supply rails with a 100-kΩ load. They offer excellent dynamic response (BW = 5.5 MHz, SR = 6 V/μs), yet quiescent current is only 750 μA. Dual and quad designs feature completely independent circuitry for lowest crosstalk and freedom from interaction.

The surface mount package options are SOIC-8 or SOT23-5 for the single (OPA340), SOIC-8 for the dual (OPA2340), and SOIC-14 surface mount for the quad (OPA4340). All are specified from –55°C to 125°C. A SPICE macromodel is available for design analysis.



Please be aware that an important notice concerning availability, standard warranty, and use in critical applications of Texas Instruments semiconductor products and disclaimers thereto appears at the end of this data sheet.

All trademarks are the property of their respective owners.



This integrated circuit can be damaged by ESD. Texas Instruments recommends that all integrated circuits be handled with appropriate precautions. Failure to observe proper handling and installation procedures can cause damage.

ESD damage can range from subtle performance degradation to complete device failure. Precision integrated circuits may be more susceptible to damage because very small parametric changes could cause the device not to meet its published specifications.

ORDERING INFORMATION⁽¹⁾

T _A	PACKAGE ⁽²⁾			ORDERABLE PART NUMBER	TOP-SIDE MARKING
–55°C to 125°C	Single	SOIC – D (8 pin)	Reel of 2500	OPA340MDREP ⁽³⁾	PREVIEW
		SOT23-5 – DBV	Reel of 250	OPA340MDBVTEP	CVS
	Dual	SOIC – D (8 pin)	Reel of 2500	OPA2340MDREP ⁽³⁾	PREVIEW
		Quad	SOIC – D (14 pin)	Reel of 2500	OPA4340MDREP ⁽³⁾

- (1) For the most current package and ordering information, see the Package Option Addendum at the end of this document, or see the TI web site at www.ti.com.
- (2) Package drawings, thermal data, and symbolization are available at www.ti.com/packaging.
- (3) Product preview. Contact your TI sales representative for availability.

ABSOLUTE MAXIMUM RATINGS⁽¹⁾

V _S	Supply voltage	5.5 V
V _I	Signal input voltage ⁽²⁾	(V–) – 0.5 V to (V+) + 0.5 V
V _O	Signal input current ⁽²⁾	10 mA
	Output short-circuit ⁽³⁾	Continuous
T _A	Operating free-air temperature range	–55°C to 125°C
T _{stg}	Storage temperature range	–55°C to 125°C
T _J	Operating virtual-junction temperature	150°C

- (1) Stresses beyond those listed under "absolute maximum ratings" may cause permanent damage to the device. These are stress ratings only, and functional operation of the device at these or any other conditions beyond those indicated under "recommended operating conditions" is not implied. Exposure to absolute-maximum-rated conditions for extended periods may affect device reliability.
- (2) Input terminals are diode-clamped to the power-supply rails. Input signals that can swing more than 0.5 V beyond the supply rails should be current limited to 10 mA or less.
- (3) Short-circuit to ground, one amplifier per package.

ELECTRICAL CHARACTERISTICS: $V_S = 2.7\text{ V to }5\text{ V}$

 Over specified temperature range ($T_A = -55^\circ\text{C to }125^\circ\text{C}$), $V_S = 5\text{ V}$, $R_L = 10\text{ k}\Omega$ connected to $V_S/2$, $V_{OUT} = V_S/2$ (unless otherwise noted)

PARAMETER	CONDITIONS		MIN	TYP	MAX	UNIT
OFFSET VOLTAGE						
Input offset voltage	V_{OS}	$V_S = 5\text{ V}$ $T_A = 25^\circ\text{C}$ $T_A = \text{Full range}$		± 150	± 500 ± 1600	μV μV
vs temperature	dV_{OS}/dT			± 2.5		$\mu\text{V}/^\circ\text{C}$
vs power supply	PSRR	$V_S = 2.7\text{ V to }5.5\text{ V}$, $V_{CM} = 0\text{ V}$		30	150	$\mu\text{V}/\text{V}$
Channel separation, dc				0.2		$\mu\text{V}/\text{V}$
INPUT BIAS CURRENT						
Input bias current	I_B			± 0.2	± 500	pA
Input offset current	I_{OS}			± 0.2	± 600	pA
NOISE						
Input voltage noise, $f = 0.1\text{ kHz to }50\text{ kHz}$				8		μVrms
Input voltage noise density, $f = 1\text{ kHz}$	e_n			25		$\text{nV}/\sqrt{\text{Hz}}$
Current noise density, $f = 1\text{ kHz}$	i_n			3		$\text{fA}/\sqrt{\text{Hz}}$
INPUT VOLTAGE RANGE						
Common-mode voltage range	V_{CM}		-0.3		$(V+) + 0.3$	V
Common-mode rejection ratio	CMRR	$-0.3\text{ V} < V_{CM} < (V+) - 1.8\text{ V}$ $T_A = 25^\circ\text{C}$ $T_A = \text{Full range}$	78	92		dB
		$V_S = 5\text{ V}$, $-0.3\text{ V} < V_{CM} < 5.3\text{ V}$ $T_A = 25^\circ\text{C}$ $T_A = \text{Full range}$	70	84		dB
		$V_S = 2.7\text{ V}$, $-0.3\text{ V} < V_{CM} < 3\text{ V}$ $T_A = 25^\circ\text{C}$	66	80		dB
INPUT IMPEDANCE						
Differential				$10^{13} \parallel 3$		$\Omega \parallel \text{pF}$
Common-mode				$10^{13} \parallel 6$		$\Omega \parallel \text{pF}$
OPEN-LOOP GAIN						
Open-loop voltage gain	A_{OL}	$R_L = 100\text{ k}\Omega$, $10\text{ mV} < V_O < (V+) - 10\text{ mV}$ $R_L = 10\text{ k}\Omega$, $70\text{ mV} < V_O < (V+) - 70\text{ mV}$ $R_L = 2\text{ k}\Omega$, $250\text{ mV} < V_O < (V+) - 250\text{ mV}$	103	124		dB
			98	120		dB
			92	114		dB
FREQUENCY RESPONSE						
Gain-bandwidth product	GBW	$G = 1$		5.5		MHz
Slew rate	SR	$V_S = 5\text{ V}$, $G = 1$, $C_L = 100\text{ pF}$		6		$\text{V}/\mu\text{s}$
Settling time, 0.1%		$V_S = 5\text{ V}$, 2-V Step, $C_L = 100\text{ pF}$		1		μs
Settling time, 0.01%		$V_S = 5\text{ V}$, 2-V Step, $C_L = 100\text{ pF}$		1.6		μs
Overload recovery time		$V_{IN} \cdot G = V_S$		0.2		μs
Total harmonic distortion + noise	THD+N	$V_S = 5\text{ V}$, $V_O = 3\text{ V}_{PP}^{(1)}$, $G = 1$, $f = 1\text{ kHz}$		0.0007		%

 (1) $V_{OUT} = 0.25\text{ V to }3.25\text{ V}$

ELECTRICAL CHARACTERISTICS: $V_S = 2.7\text{ V to }5\text{ V}$ (continued)

Over specified temperature range ($T_A = -55^\circ\text{C to }125^\circ\text{C}$), $V_S = 5\text{ V}$, $R_L = 10\text{ k}\Omega$ connected to $V_S/2$, $V_{OUT} = V_S/2$ (unless otherwise noted)

PARAMETER	CONDITIONS	MIN	TYP	MAX	UNIT
OUTPUT					
Voltage output swing from rail ⁽²⁾	$R_L = 100\text{ k}\Omega$, $A_{OL} \geq 104\text{ dB}$		1	10	mV
	$R_L = 10\text{ k}\Omega$, $A_{OL} \geq 98\text{ dB}$		10	70	mV
	$R_L = 2\text{ k}\Omega$, $A_{OL} \geq 92\text{ dB}$		40	250	mV
Short-circuit current	I_{SC}		± 50		mA
Capacitive load drive	C_{LOAD}	See Typical Characteristics			
POWER SUPPLY					
Specified voltage range	V_S	2.7		5	V
Operating voltage range			2.5 to 5.5		V
Quiescent current (per amplifier)	I_Q	$I_O = 0$, $V_S = 5\text{ V}$			
			750	950	μA
				1300	μA
					$T_A = 25^\circ\text{C}$
					$T_A = \text{Full range}$
TEMPERATURE RANGE					
Specified range		-55		125	$^\circ\text{C}$
Storage range		-55		125	$^\circ\text{C}$
Thermal resistance	θ_{JA}				
DBV (5 pin) package			200		$^\circ\text{C/W}$
D (8 pin) package			150		$^\circ\text{C/W}$
D (14 pin) package			100		$^\circ\text{C/W}$

(2) Output voltage swings are measured between the output and power supply rails.

TYPICAL CHARACTERISTICS

At $T_A = 25^\circ\text{C}$, $V_S = 5\text{ V}$, and $R_L = 10\text{ k}\Omega$ connected to $V_S/2$ (unless otherwise noted)

OPEN-LOOP GAIN/PHASE vs FREQUENCY

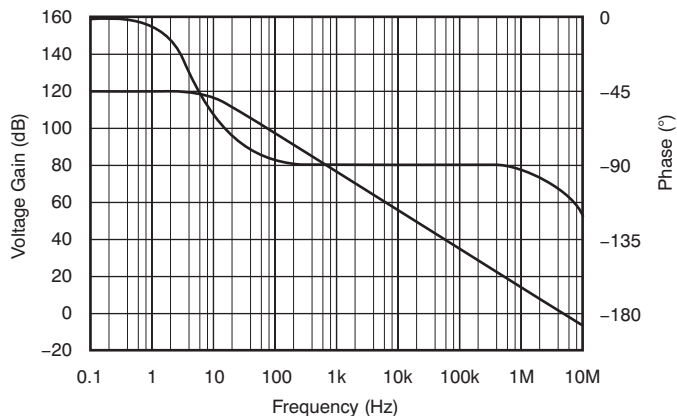

Figure 1.

POWER-SUPPLY AND COMMON-MODE REJECTION vs FREQUENCY

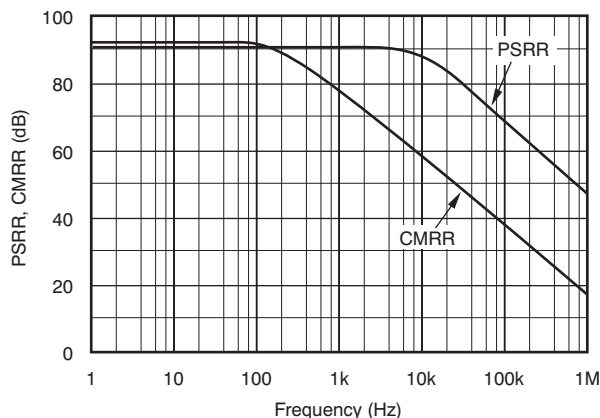

Figure 2.

INPUT VOLTAGE AND CURRENT NOISE SPECTRAL DENSITY vs FREQUENCY

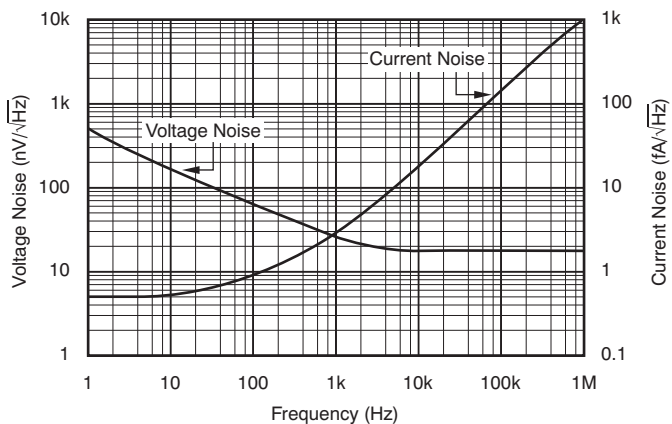

Figure 3.

CHANNEL SEPARATION vs FREQUENCY

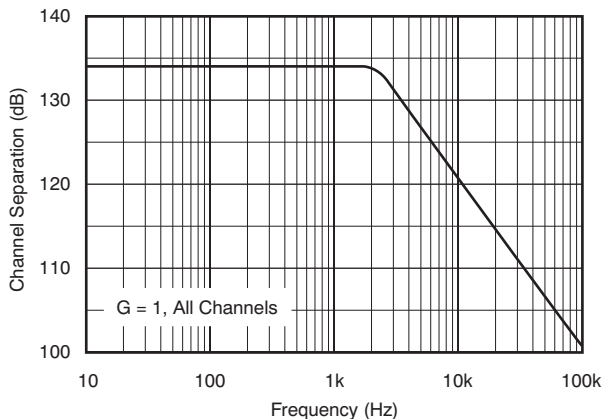

Figure 4.

TOTAL HARMONIC DISTORTION + NOISE vs FREQUENCY

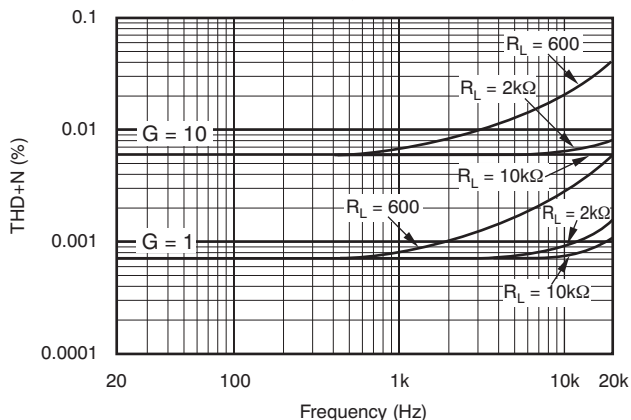

Figure 5.

CLOSED-LOOP OUTPUT IMPEDANCE vs FREQUENCY

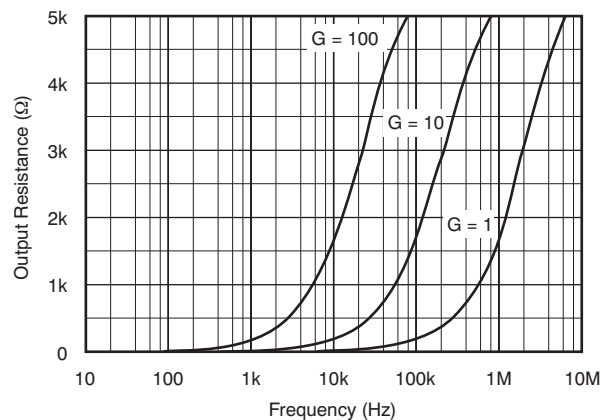

Figure 6.

TYPICAL CHARACTERISTICS (continued)

At $T_A = 25^\circ\text{C}$, $V_S = 5\text{ V}$, and $R_L = 10\text{ k}\Omega$ connected to $V_S/2$ (unless otherwise noted)

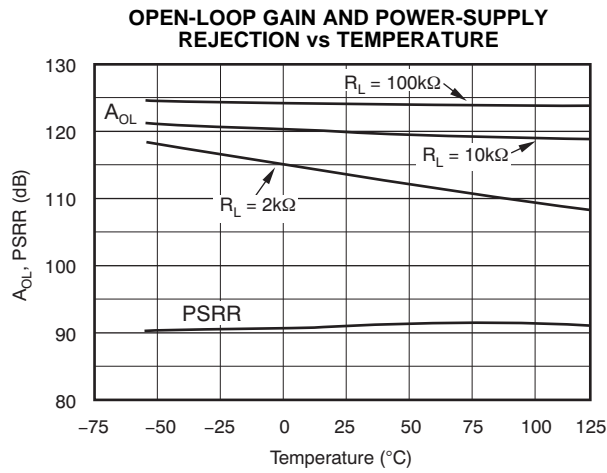

Figure 7.

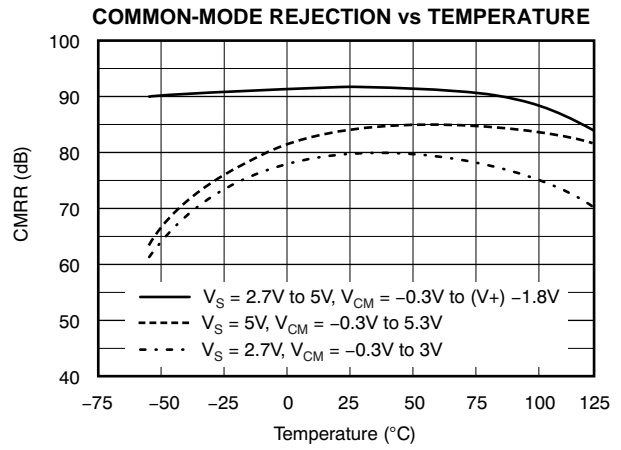

Figure 8.

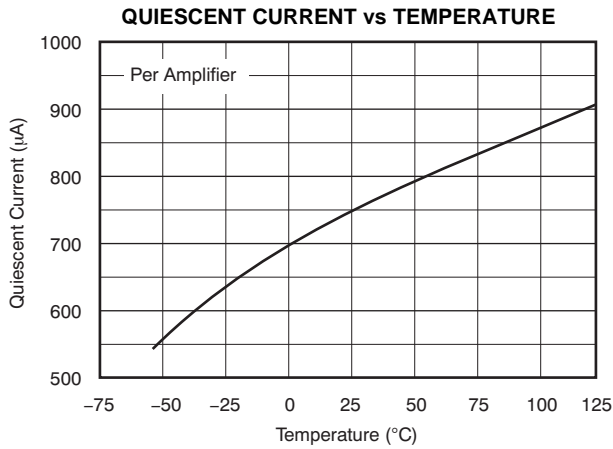

Figure 9.

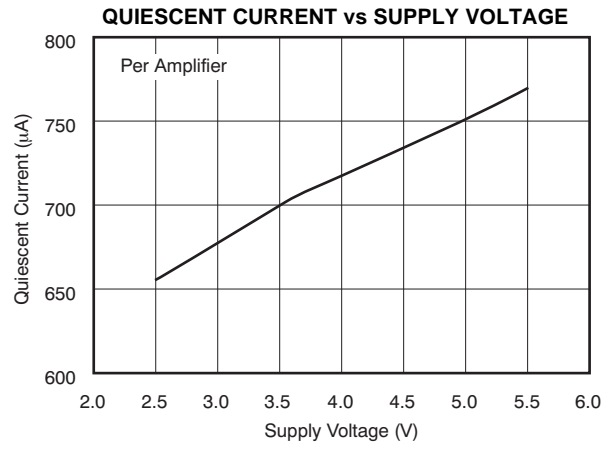

Figure 10.

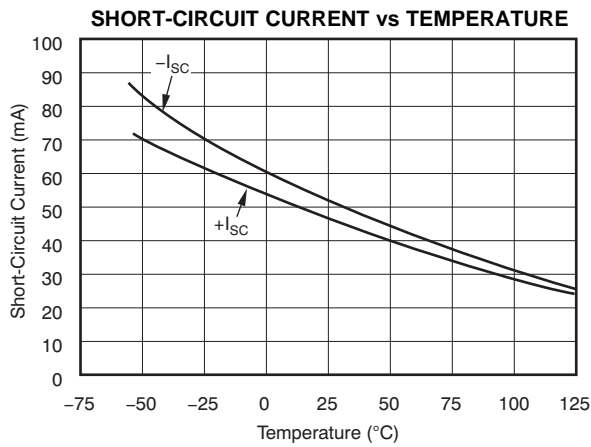

Figure 11.

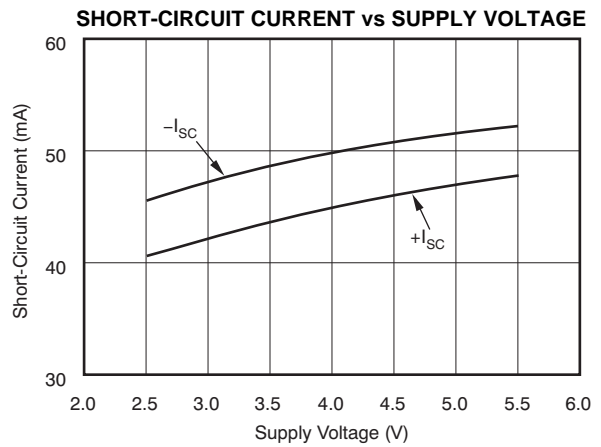

Figure 12.

TYPICAL CHARACTERISTICS (continued)

At $T_A = 25^\circ\text{C}$, $V_S = 5\text{ V}$, and $R_L = 10\text{ k}\Omega$ connected to $V_S/2$ (unless otherwise noted)

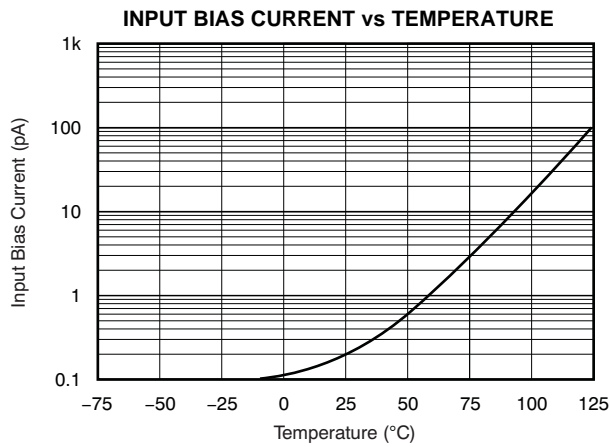

Figure 13.

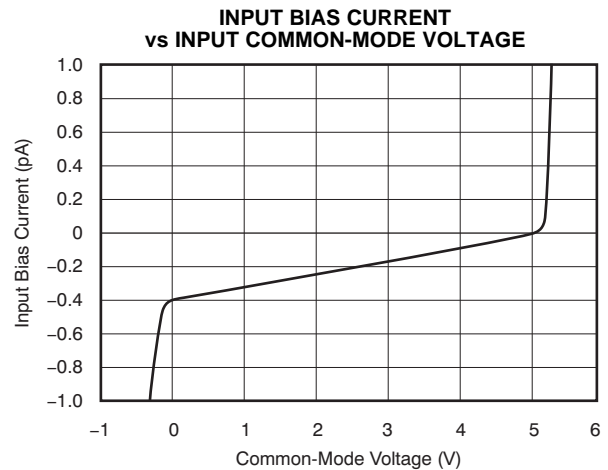

Figure 14.

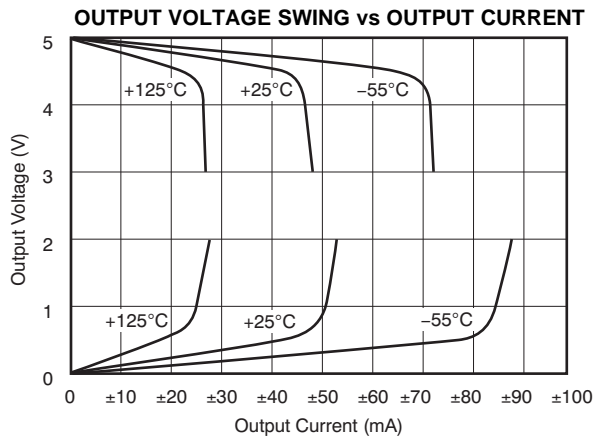

Figure 15.

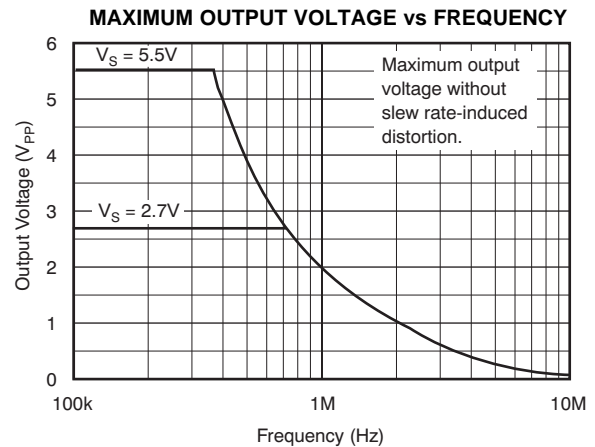

Figure 16.

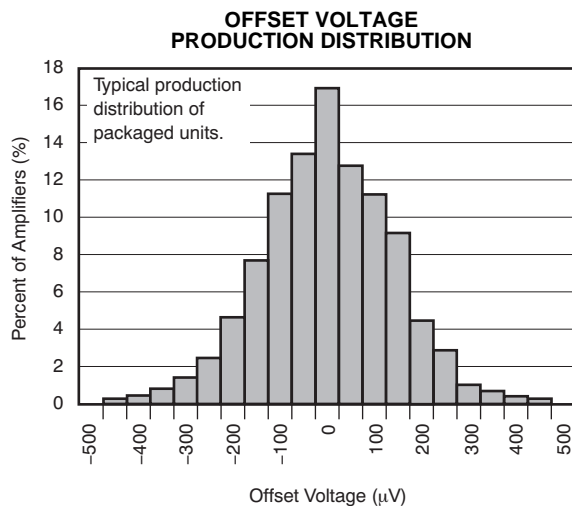

Figure 17.

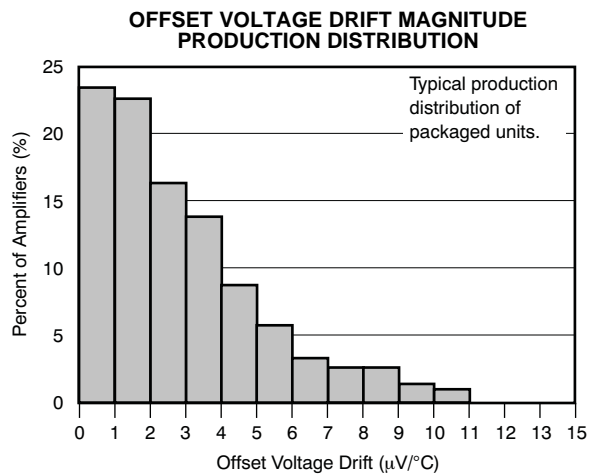

Figure 18.

TYPICAL CHARACTERISTICS (continued)

At $T_A = 25^\circ\text{C}$, $V_S = 5\text{ V}$, and $R_L = 10\text{ k}\Omega$ connected to $V_S/2$ (unless otherwise noted)

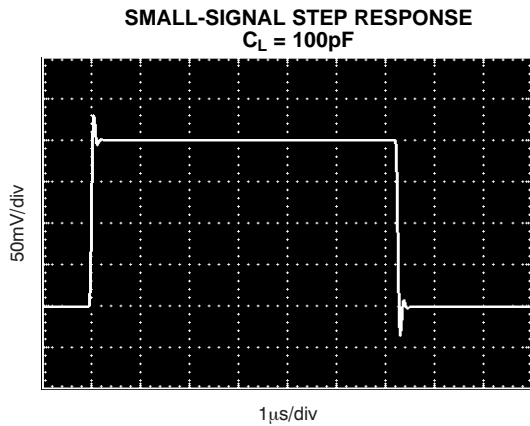

Figure 19.

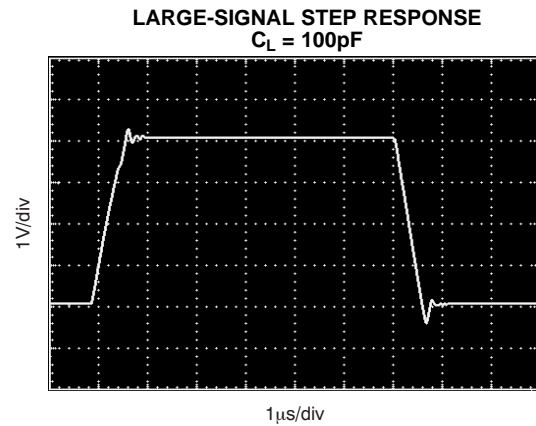

Figure 20.

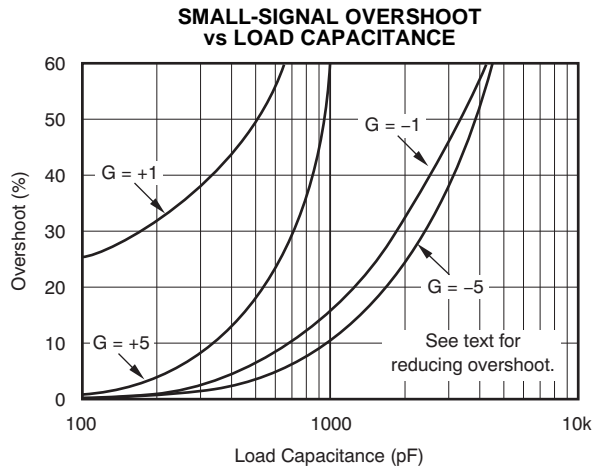

Figure 21.

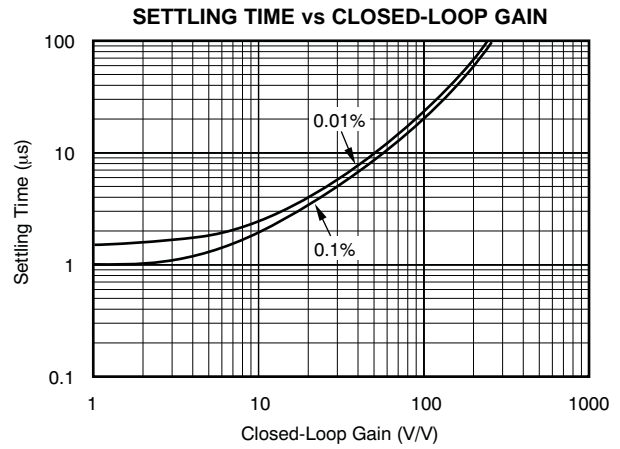

Figure 22.

APPLICATION INFORMATION

OPA340 series operational amplifiers are fabricated on a state-of-the-art 0.6-micron CMOS process. They are unity-gain stable and suitable for a wide range of general-purpose applications. Rail-to-rail input/output make them ideal for driving sampling A/D converters. In addition, excellent ac performance makes them well-suited for audio applications. The class AB output stage is capable of driving 600- Ω loads connected to any point between V_+ and ground.

Rail-to-rail input and output swing significantly increases dynamic range, especially in low-supply applications. Figure 23 shows the input and output waveforms for the OPA340 in unity-gain configuration. Operation is from a single 5-V supply with a 10-k Ω load connected to $V_S/2$. The input is a 5- V_{PP} sinusoid. Output voltage is approximately 4.98 V_{PP} .

Power-supply pins should be bypassed with 0.01- μ F ceramic capacitors.

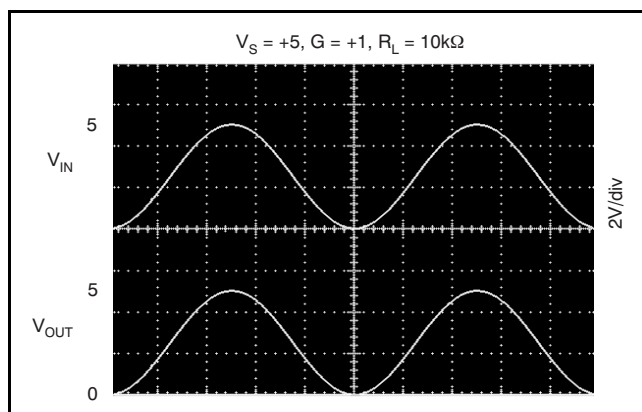

Figure 23. Rail-to-Rail Input and Output

Operating Voltage

OPA340 series operational amplifiers are fully specified from 2.7 V to 5 V. Parameters are ensured over the specified supply range—a unique feature of the OPA340 series. In addition, many specifications

apply from -55°C to 125°C . Most behavior remains nearly unchanged throughout the full operating voltage range. Parameters that vary significantly with operating voltages or temperature are shown in [Typical Characteristics](#).

Rail-to-Rail Input

The input common-mode voltage range of the OPA340 series extends 500 mV beyond the supply rails. This is achieved with a complementary input stage—an N-channel input differential pair in parallel with a P-channel differential pair (as shown in Figure 24). The N-channel pair is active for input voltages close to the positive rail, typically $(V_+) - 1.3\text{ V}$ to 500 mV above the positive supply, while the P-channel pair is on for inputs from 500 mV below the negative supply to approximately $(V_+) - 1.3\text{ V}$. There is a small transition region, typically $(V_+) - 1.5\text{ V}$ to $(V_+) - 1.1\text{ V}$, in which both pairs are on. This 400-mV transition region can vary $\pm 300\text{ mV}$ with process variation. Thus, the transition region (both stages on) can range from $(V_+) - 1.8\text{ V}$ to $(V_+) - 1.4\text{ V}$ on the low end, up to $(V_+) - 1.2\text{ V}$ to $(V_+) - 0.8\text{ V}$ on the high end.

OPA340 series operational amplifiers are laser-trimmed to reduce the offset voltage difference between the N-channel and P-channel input stages, resulting in improved common-mode rejection and a smooth transition between the N-channel pair and the P-channel pair. However, within the 400-mV transition region PSRR, CMRR, offset voltage, offset drift, and THD may be degraded compared to operation outside this region.

A double-folded cascode adds the signal from the two input pairs and presents a differential signal to the class AB output stage. Normally, input bias current is approximately 200 fA; however, input voltages exceeding the power supplies by more than 500 mV can cause excessive current to flow in or out of the input pins. Momentary voltages greater than 500 mV beyond the power supply can be tolerated if the current on the input pins is limited to 10 mA. This is easily accomplished with an input resistor, as shown in Figure 25. Many input signals are inherently current-limited to less than 10 mA; therefore, a limiting resistor is not required.

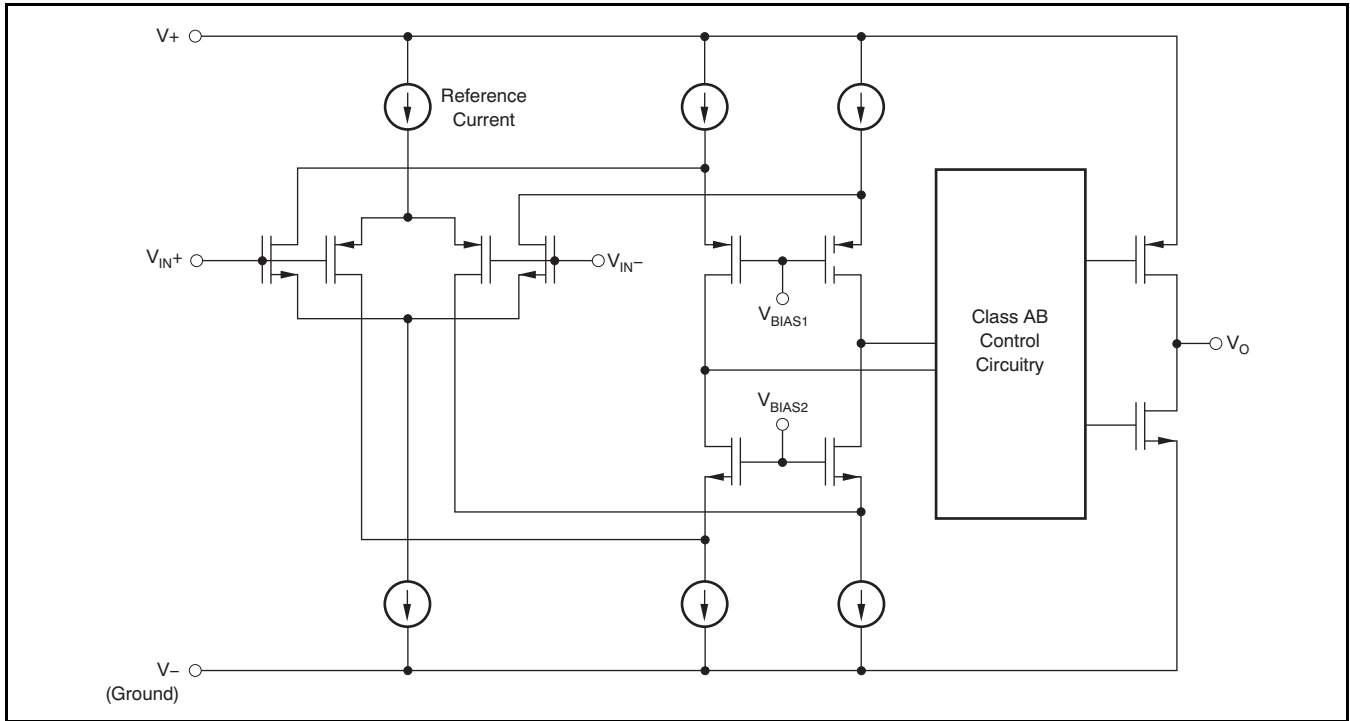

Figure 24. Simplified Schematic

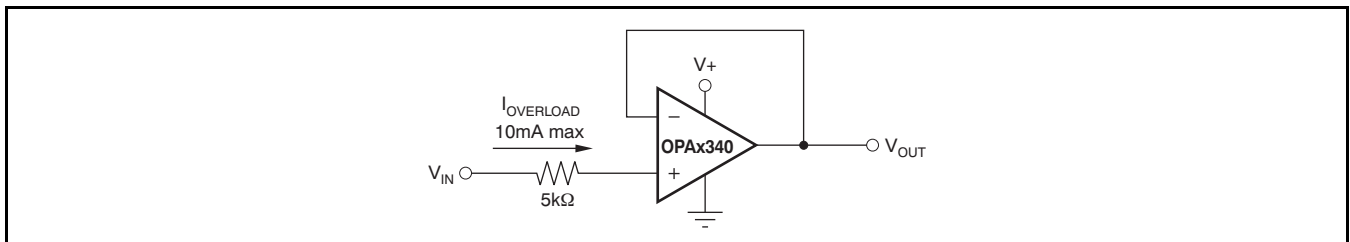

Figure 25. Input Current Protection for Voltages Exceeding the Supply Voltage

RAIL-TO-RAIL OUTPUT

A class AB output stage with common-source transistors is used to achieve rail-to-rail output. For light resistive loads ($> 50 \text{ k}\Omega$), the output voltage is typically a few millivolts from the supply rails. With

moderate resistive loads ($2 \text{ k}\Omega$ to $50 \text{ k}\Omega$), the output can swing to within a few tens of millivolts from the supply rails and maintain high open-loop gain. See the typical characteristic curve [Output Voltage Swing vs Output Current](#).

CAPACITIVE LOAD AND STABILITY

OPA340 series operational amplifiers can drive a wide range of capacitive loads. However, all operational amplifiers under certain conditions may become unstable. Op amp configuration, gain, and load value are just a few of the factors to consider when determining stability. An operational amplifier in unity gain configuration is most susceptible to the effects of capacitive load. The capacitive load reacts with the operational amplifier's output resistance, along with any additional load resistance, to create a pole in the small-signal response which degrades the phase margin. In unity gain, OPA340 series operational amplifiers perform well, with a pure capacitive load up to approximately 1000 pF. Increasing gain enhances the amplifier's ability to drive more capacitance. See the typical performance curve [Small-Signal Overshoot vs Capacitive Load](#).

One method of improving capacitive load drive in the unity gain configuration is to insert a 10-Ω to 20-Ω resistor in series with the output, as shown in [Figure 26](#). This significantly reduces ringing with large capacitive loads. However, if there is a resistive load in parallel with the capacitive load, it creates a voltage divider introducing a dc error at the output and slightly reduces output swing. This error may be insignificant. For example, with $R_L = 10\text{ k}\Omega$ and $R_S = 20\ \Omega$, there is only approximately 0.2% error at the output.

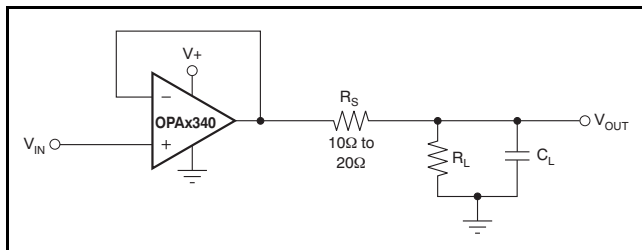

Figure 26. Series Resistor in Unity-Gain Configuration Improves Capacitive Load Drive

DRIVING A/D CONVERTERS

OPA340 series operational amplifiers are optimized for driving medium speed (up to 100 kHz) sampling A/D converters. However, they also offer excellent performance for higher speed converters. The OPA340 series provides an effective means of buffering the A/D converter's input capacitance and resulting charge injection while providing signal gain. [Figure 27](#) and [Figure 28](#) show the OPA340 driving an [ADS7816](#). The [ADS7816](#) is a 12-bit, micro-power sampling converter in the tiny MSOP-8 package. When used with the miniature package options of the OPA340 series, the combination is ideal for space-limited and low-power applications. For further information consult the [ADS7816 data sheet](#). With the OPA340 in a noninverting configuration, an RC network at the amplifier's output can be used to filter high-frequency noise in the signal (see [Figure 27](#)). In the inverting configuration, filtering may be accomplished with a capacitor across the feedback resistor (see [Figure 28](#)).

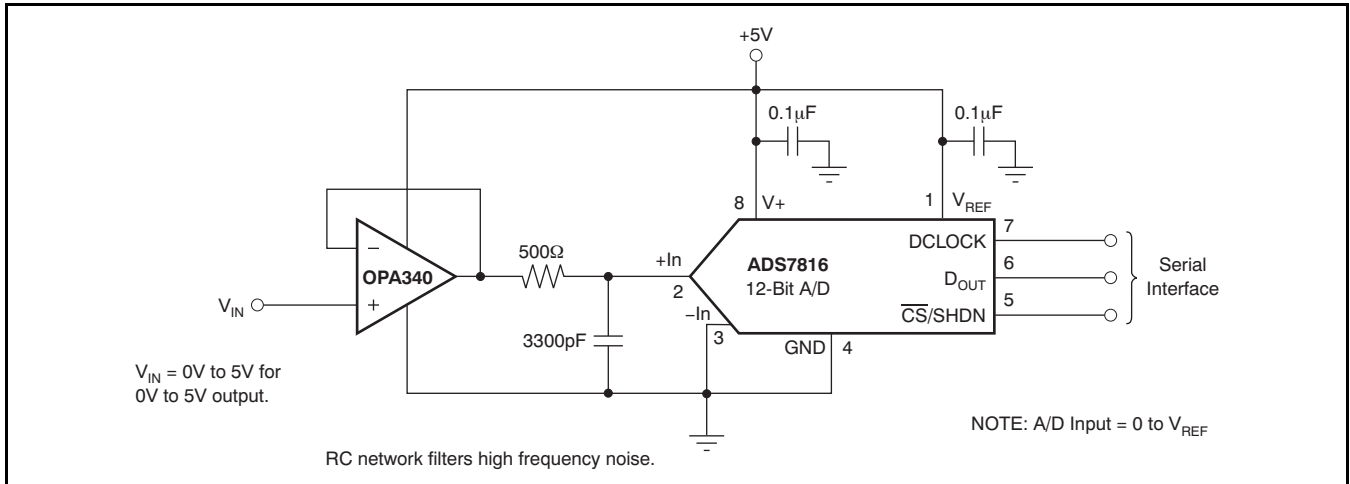

Figure 27. OPA340 in Noninverting Configuration Driving ADS7816

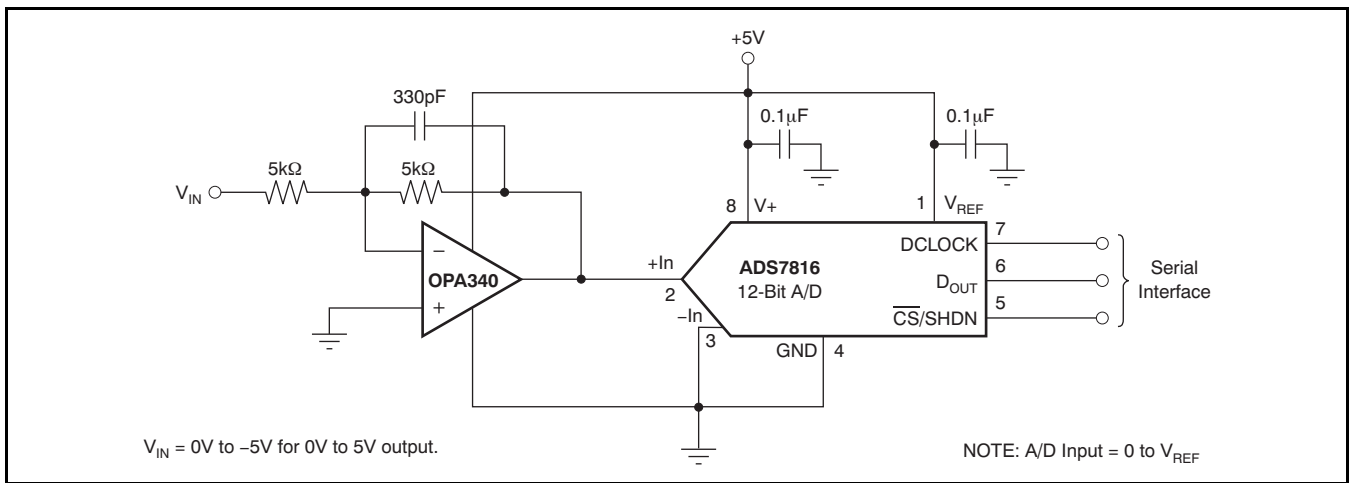

Figure 28. OPA340 in Inverting Configuration Driving ADS7816

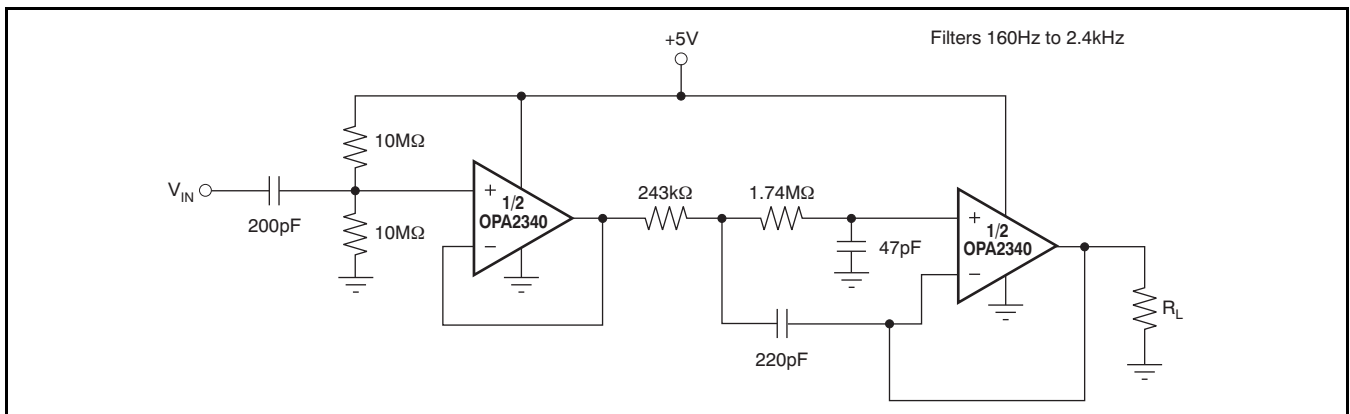

Figure 29. Speech Bandpass Filter

PACKAGING INFORMATION

Orderable Device	Status ⁽¹⁾	Package Type	Package Drawing	Pins	Package Qty	Eco Plan ⁽²⁾	Lead/Ball Finish	MSL Peak Temp ⁽³⁾
OPA340MDBVTEP	ACTIVE	SOT-23	DBV	5	250	Green (RoHS & no Sb/Br)	CU NIPDAU	Level-2-260C-1 YEAR
V62/08618-01XE	ACTIVE	SOT-23	DBV	5	250	Green (RoHS & no Sb/Br)	CU NIPDAU	Level-2-260C-1 YEAR

⁽¹⁾ The marketing status values are defined as follows:

ACTIVE: Product device recommended for new designs.

LIFEBUY: TI has announced that the device will be discontinued, and a lifetime-buy period is in effect.

NRND: Not recommended for new designs. Device is in production to support existing customers, but TI does not recommend using this part in a new design.

PREVIEW: Device has been announced but is not in production. Samples may or may not be available.

OBsolete: TI has discontinued the production of the device.

⁽²⁾ Eco Plan - The planned eco-friendly classification: Pb-Free (RoHS), Pb-Free (RoHS Exempt), or Green (RoHS & no Sb/Br) - please check <http://www.ti.com/productcontent> for the latest availability information and additional product content details.

TBD: The Pb-Free/Green conversion plan has not been defined.

Pb-Free (RoHS): TI's terms "Lead-Free" or "Pb-Free" mean semiconductor products that are compatible with the current RoHS requirements for all 6 substances, including the requirement that lead not exceed 0.1% by weight in homogeneous materials. Where designed to be soldered at high temperatures, TI Pb-Free products are suitable for use in specified lead-free processes.

Pb-Free (RoHS Exempt): This component has a RoHS exemption for either 1) lead-based flip-chip solder bumps used between the die and package, or 2) lead-based die adhesive used between the die and leadframe. The component is otherwise considered Pb-Free (RoHS compatible) as defined above.

Green (RoHS & no Sb/Br): TI defines "Green" to mean Pb-Free (RoHS compatible), and free of Bromine (Br) and Antimony (Sb) based flame retardants (Br or Sb do not exceed 0.1% by weight in homogeneous material)

⁽³⁾ MSL, Peak Temp. -- The Moisture Sensitivity Level rating according to the JEDEC industry standard classifications, and peak solder temperature.

Important Information and Disclaimer:The information provided on this page represents TI's knowledge and belief as of the date that it is provided. TI bases its knowledge and belief on information provided by third parties, and makes no representation or warranty as to the accuracy of such information. Efforts are underway to better integrate information from third parties. TI has taken and continues to take reasonable steps to provide representative and accurate information but may not have conducted destructive testing or chemical analysis on incoming materials and chemicals. TI and TI suppliers consider certain information to be proprietary, and thus CAS numbers and other limited information may not be available for release.

In no event shall TI's liability arising out of such information exceed the total purchase price of the TI part(s) at issue in this document sold by TI to Customer on an annual basis.

OTHER QUALIFIED VERSIONS OF OPA340-EP :

- Catalog: [OPA340](#)

NOTE: Qualified Version Definitions:

- Catalog - TI's standard catalog product

TAPE AND REEL INFORMATION



QUADRANT ASSIGNMENTS FOR PIN 1 ORIENTATION IN TAPE



*All dimensions are nominal

Device	Package Type	Package Drawing	Pins	SPQ	Reel Diameter (mm)	Reel Width W1 (mm)	A0 (mm)	B0 (mm)	K0 (mm)	P1 (mm)	W (mm)	Pin1 Quadrant
OPA340MDBVTEP	SOT-23	DBV	5	250	179.0	8.4	3.2	3.2	1.4	4.0	8.0	Q3

TAPE AND REEL BOX DIMENSIONS



*All dimensions are nominal

Device	Package Type	Package Drawing	Pins	SPQ	Length (mm)	Width (mm)	Height (mm)
OPA340MDBVTEP	SOT-23	DBV	5	250	195.0	200.0	45.0

DBV (R-PDSO-G5)

PLASTIC SMALL-OUTLINE PACKAGE



- NOTES:
- A. All linear dimensions are in millimeters.
 - B. This drawing is subject to change without notice.
 - C. Body dimensions do not include mold flash or protrusion. Mold flash and protrusion shall not exceed 0.15 per side.
 - D. Falls within JEDEC MO-178 Variation AA.

IMPORTANT NOTICE

Texas Instruments Incorporated and its subsidiaries (TI) reserve the right to make corrections, modifications, enhancements, improvements, and other changes to its products and services at any time and to discontinue any product or service without notice. Customers should obtain the latest relevant information before placing orders and should verify that such information is current and complete. All products are sold subject to TI's terms and conditions of sale supplied at the time of order acknowledgment.

TI warrants performance of its hardware products to the specifications applicable at the time of sale in accordance with TI's standard warranty. Testing and other quality control techniques are used to the extent TI deems necessary to support this warranty. Except where mandated by government requirements, testing of all parameters of each product is not necessarily performed.

TI assumes no liability for applications assistance or customer product design. Customers are responsible for their products and applications using TI components. To minimize the risks associated with customer products and applications, customers should provide adequate design and operating safeguards.

TI does not warrant or represent that any license, either express or implied, is granted under any TI patent right, copyright, mask work right, or other TI intellectual property right relating to any combination, machine, or process in which TI products or services are used. Information published by TI regarding third-party products or services does not constitute a license from TI to use such products or services or a warranty or endorsement thereof. Use of such information may require a license from a third party under the patents or other intellectual property of the third party, or a license from TI under the patents or other intellectual property of TI.

Reproduction of TI information in TI data books or data sheets is permissible only if reproduction is without alteration and is accompanied by all associated warranties, conditions, limitations, and notices. Reproduction of this information with alteration is an unfair and deceptive business practice. TI is not responsible or liable for such altered documentation. Information of third parties may be subject to additional restrictions.

Resale of TI products or services with statements different from or beyond the parameters stated by TI for that product or service voids all express and any implied warranties for the associated TI product or service and is an unfair and deceptive business practice. TI is not responsible or liable for any such statements.

TI products are not authorized for use in safety-critical applications (such as life support) where a failure of the TI product would reasonably be expected to cause severe personal injury or death, unless officers of the parties have executed an agreement specifically governing such use. Buyers represent that they have all necessary expertise in the safety and regulatory ramifications of their applications, and acknowledge and agree that they are solely responsible for all legal, regulatory and safety-related requirements concerning their products and any use of TI products in such safety-critical applications, notwithstanding any applications-related information or support that may be provided by TI. Further, Buyers must fully indemnify TI and its representatives against any damages arising out of the use of TI products in such safety-critical applications.

TI products are neither designed nor intended for use in military/aerospace applications or environments unless the TI products are specifically designated by TI as military-grade or "enhanced plastic." Only products designated by TI as military-grade meet military specifications. Buyers acknowledge and agree that any such use of TI products which TI has not designated as military-grade is solely at the Buyer's risk, and that they are solely responsible for compliance with all legal and regulatory requirements in connection with such use.

TI products are neither designed nor intended for use in automotive applications or environments unless the specific TI products are designated by TI as compliant with ISO/TS 16949 requirements. Buyers acknowledge and agree that, if they use any non-designated products in automotive applications, TI will not be responsible for any failure to meet such requirements.

Following are URLs where you can obtain information on other Texas Instruments products and application solutions:

Products

Amplifiers	amplifier.ti.com
Data Converters	dataconverter.ti.com
DSP	dsp.ti.com
Clocks and Timers	www.ti.com/clocks
Interface	interface.ti.com
Logic	logic.ti.com
Power Mgmt	power.ti.com
Microcontrollers	microcontroller.ti.com
RFID	www.ti-rfid.com
RF/IF and ZigBee® Solutions	www.ti.com/lprf

Applications

Audio	www.ti.com/audio
Automotive	www.ti.com/automotive
Broadband	www.ti.com/broadband
Digital Control	www.ti.com/digitalcontrol
Medical	www.ti.com/medical
Military	www.ti.com/military
Optical Networking	www.ti.com/opticalnetwork
Security	www.ti.com/security
Telephony	www.ti.com/telephony
Video & Imaging	www.ti.com/video
Wireless	www.ti.com/wireless

Mailing Address: Texas Instruments, Post Office Box 655303, Dallas, Texas 75265
Copyright © 2008, Texas Instruments Incorporated